

# ASSEMBLE INSTRUCTION

Cam Lock/Dowel Placement Supplement

CONNECTING ROD 1      CORRECT 2      3

\*NOTE: DO NOT USE AN AUTOMATIC SCREWDRIVER TO TIGHTEN CAM LOCKS. DO NOT OVER-TIGHTEN.

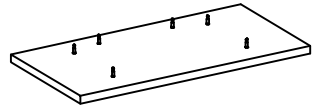

Top plate :800x400x25=1

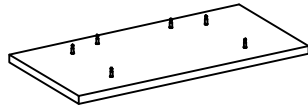

Top plate :800x400x25=1

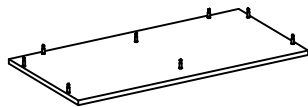

bottom plate :800x400x25=1

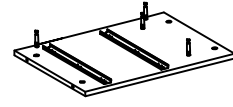

Right side plate :527x396x15=1

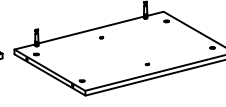

Left side plate :527x396x15=1

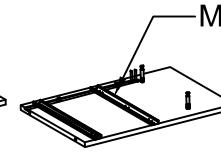

Middle plate :527x358x15=1

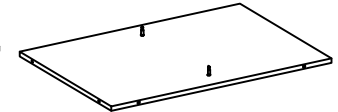

Back plate :527x766x15=1

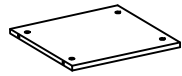

Middle partition plate :375x358x15=1



Middle partition plate :374x352x15=1



Support foot plate :450x100x15=1



Support foot plate :300x100x15=2



Foot plate :380x54x15=2

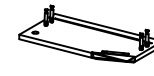

On drawer plate :380x200x15=1

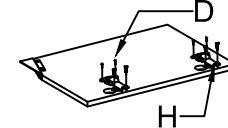

Door plank :380x200x15=1



Foot plate :750x54x15=2



Down drawer plate :380x200x15=1

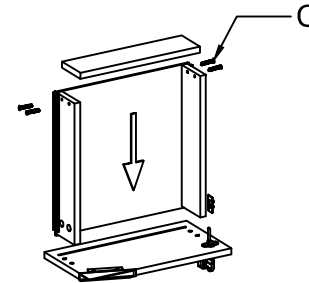
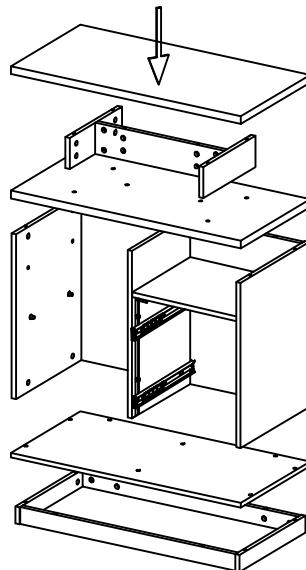
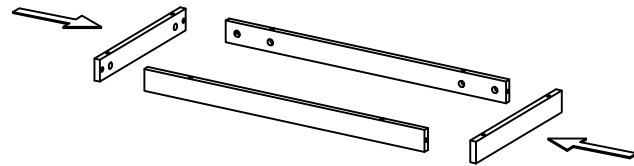

Other Drawer Press Install

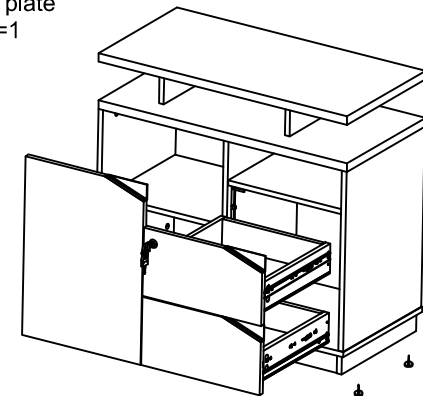

No.	A	B	C	D	E	F	G	H	I	J	K	L
PARTS LIST												
			M3.5x30	M3.5x14	14"							
QTY	60	60	8	40	2	8	4	2	2	1	2	1

